



We reserve the right for any inaccuracies and the right to make changes. The sketches are for guidance only.

C. **Niche** lighting

Assembly sketches

C. Niche lighting

Different ways of installing lighting in niches

C1. Installation with L-profile

Raking light with concealed LEDstrip behind L-profile. LED-strip is fitted over the screw head and lights downwards. An easy way to create the impression of a niche with a profile, without building a niche. The profile has no end caps and should be installed between two walls for the neatest fitting.

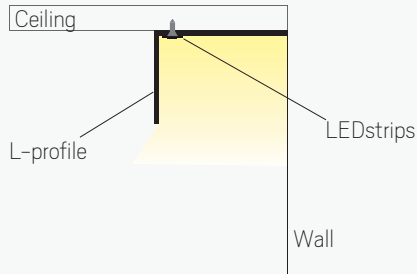

Recommended profile:

Art Hide

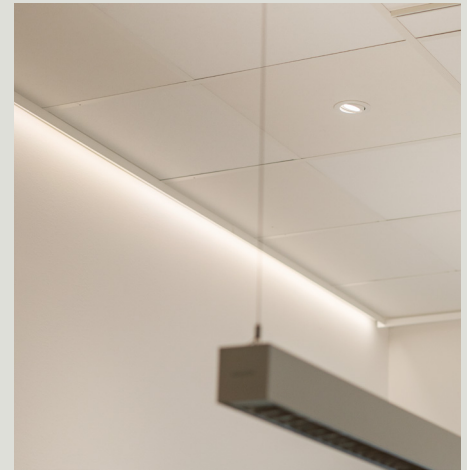
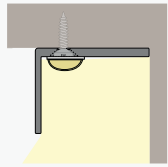

C2. Installation behind cornice/skirting/screening

The profile is installed behind a cornice/skirting/screening to give a raking light on the wall. The profile is pre-drilled with countersinking by an electrician, alternatively mounted with clips.

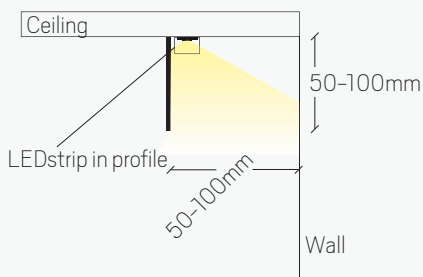

Recommended profile and covers:

Art Low

Art High

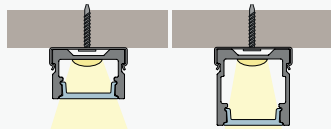

Cover Opal/ Lens

Cover Opal/ Lens

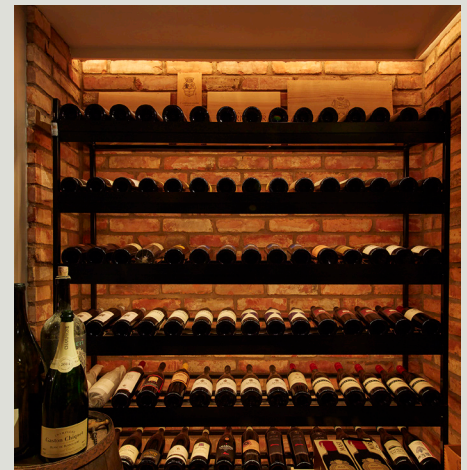

C. Niche lighting

Different ways of installing lighting in niches

C3. Installation in niche built on site

The profile is installed in a niche that is built on site, to give a raking light on the wall. The profile is pre-drilled with countersinking by an electrician, alternatively mounted with clips.

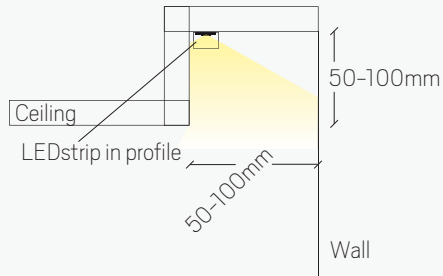

Recommended profiles and covers:

Art High

Art Low

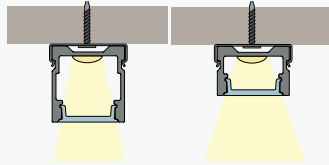

Cover Opal or
Lens 30°

Cover Opal or
Lens 30°

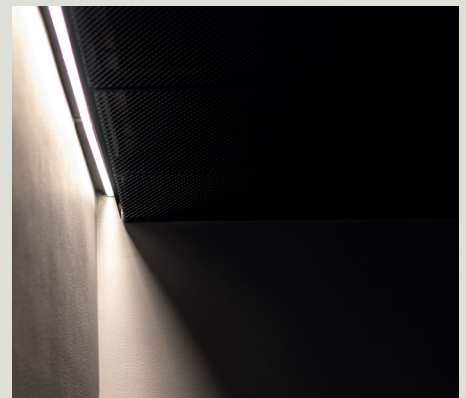

C4. Installation in niche built on site - bathroom

The profile is installed in a niche that is built on site, to give a raking light on the wall. The profile is screwed into place. We recommend LEDstrip Line IP67 for this solution.

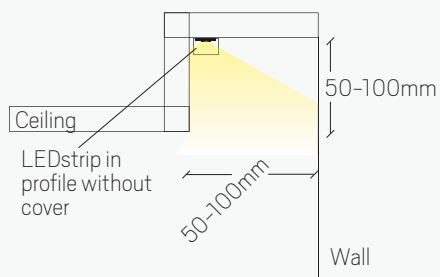

Recommended profiles and covers:

Art Slim

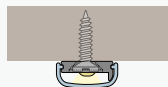

Excl. cover

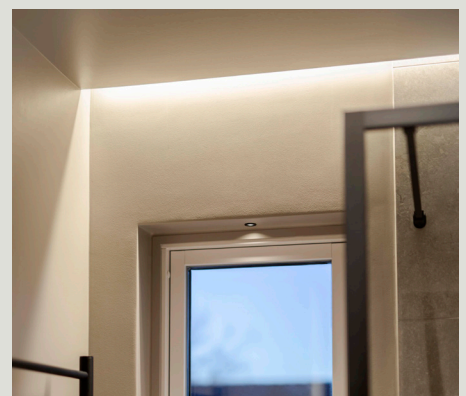
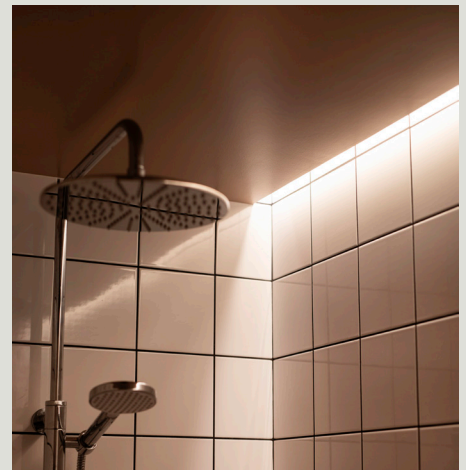

C. Niche lighting

Different ways of installing lighting in niches

C5. Installation in niche built on site - indirect

Indirect raking light on wall, concealed in false ceiling. We recommend LEDstrip Line IP67 for this solution.

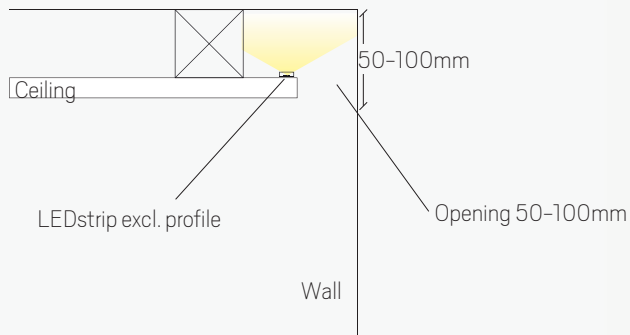

C6. Installation in niche built on site - by floor

The profile is installed under a batten in a niche built on site by the floor. We recommend LEDstrip Line IP67 for this solution.

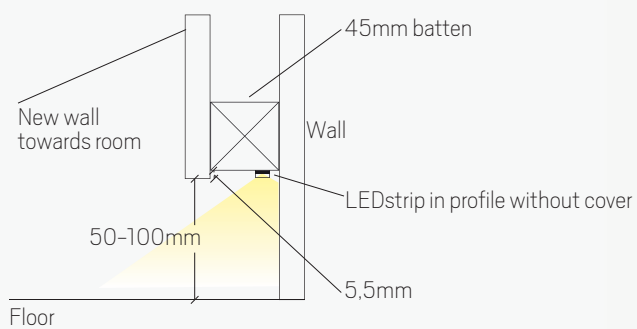

Art Slim

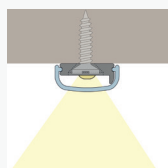

Excl. cover



C. Niche lighting

Different ways of installing lighting in niches

C7. Installation by skirting

The profile is installed by the skirting so as to light downwards towards the floor. The profile is screwed into place. We recommend LEDstrip Line IP67 for this solution.

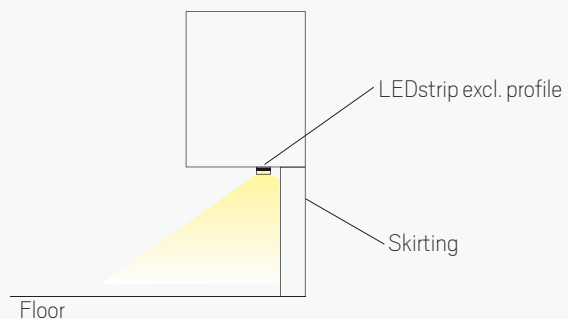

Art Slim

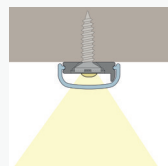

Excl. cover



OVERVIEW TABLE PROFILES, LED STRIPS AND COVERS

When choosing LEDstrip, we recommend that you choose a light green/blue combination for best results with visible installation.

	W/m	Width mm	LED/m	7392971132670 PROFIL ART LOW MAX 18W/M	7392971132709 PROFIL ART HIGH MAX 23W/M	7392971132730 PROFIL ART CORNER MAX 34W/M	7392971140117 PROFIL ART SLIM MAX 15W/M	7392971142340 PROFIL ART HIDE MAX 30W/M	7392971153032 PROFIL 30x30 MAX 34W/M	7392971153063 PROFIL 30x30 Recessed MAX 36W/M	7392971125473 PROFIL HIDDEN MAX 28W/M	7392971125534 PROFIL DUAL MAX 28W/M	7392971121390 PROFIL U HÖG MAX 21W/M	7392971121529 PROFIL T MAX 31W/M	7392971125480 PROFIL STAIR MAX 23W/M	7392971121406 PROFIL U LÄG MAX 17W/M	7392971125282 PROFIL LEAN MAX 16W/M	7392971140308 PROFIL ART THIN MAX 17W/M	7392971125442 PROFIL WEDGE MAX 20W/M	7392971129822 PROFIL MICROU MAX 12W/M	7392971129839 PROFIL MICROT MAX 14W/M
LEDstrip 12V R IP20	4,8	8	60	Light Green	Light Green	Light Green	Light Green	Light Green	Light Green	Light Green	Light Green	Light Green	Light Green	Light Green	Light Green	Light Green	Light Green	Light Green	Light Green	Light Green	Light Green
LEDstrip 24V IP20 Lowlum	4,4	8	70	Light Green	Light Green	Light Green	Light Green	Light Green	Light Green	Light Green	Light Green	Light Green	Light Green	Light Green	Light Green	Light Green	Light Green	Light Green	Light Green	Light Green	Light Green
LEDstrip 24V IP20 Midlum	9,6	8	168	Light Green	Light Green	Light Green	Light Green	Light Green	Light Green	Light Green	Light Green	Light Green	Light Green	Light Green	Light Green	Light Green	Light Green	Light Green	Light Green	Light Green	Light Green
LEDstrip 24V IP20 Highlum	12,8	8	160	Light Green	Light Green	Light Green	Light Green	Light Green	Light Green	Light Green	Light Green	Light Green	Light Green	Light Green	Light Green	Light Green	Light Green	Light Green	Light Green	Light Green	Light Green
LEDstrip RX TUNE IP20	12	8	60	Light Green	Light Green	Light Green	Light Green	Light Green	Light Green	Light Green	Light Green	Light Green	Light Green	Light Green	Light Green	Light Green	Light Green	Light Green	Light Green	Light Green	Light Green
LEDstrip RXM IP20	7,5	3,5	120	Light Green	Light Green	Light Green	Light Green	Light Green	Light Green	Light Green	Light Green	Light Green	Light Green	Light Green	Light Green	Light Green	Light Green	Light Green	Light Green	Light Green	Light Green
LEDstrip 24V Long IP20	8	10	120	Light Green	Light Green	Light Green	Light Green	Light Green	Light Green	Light Green	Light Green	Light Green	Light Green	Light Green	Light Green	Light Green	Light Green	Light Green	Light Green	Light Green	Light Green
LEDstrip 24V Line IP20	10	8	512	Light Green	Light Green	Light Green	Light Green	Light Green	Light Green	Light Green	Light Green	Light Green	Light Green	Light Green	Light Green	Light Green	Light Green	Light Green	Light Green	Light Green	Light Green
LEDstrip 12V R IP67	4,8	10	60	Light Green	Light Green	Light Green	Light Green	Light Green	Light Green	Light Green	Light Green	Light Green	Light Green	Light Green	Light Green	Light Green	Light Green	Light Green	Light Green	Light Green	Light Green
LEDstrip 24V IP67 Lowlum	4,4	10	70	Light Green	Light Green	Light Green	Light Green	Light Green	Light Green	Light Green	Light Green	Light Green	Light Green	Light Green	Light Green	Light Green	Light Green	Light Green	Light Green	Light Green	Light Green
LEDstrip 24V IP67 Midlum	9,6	10	168	Light Green	Light Green	Light Green	Light Green	Light Green	Light Green	Light Green	Light Green	Light Green	Light Green	Light Green	Light Green	Light Green	Light Green	Light Green	Light Green	Light Green	Light Green
LEDstrip 24V IP67 Highlum	12,8	10	160	Light Green	Light Green	Light Green	Light Green	Light Green	Light Green	Light Green	Light Green	Light Green	Light Green	Light Green	Light Green	Light Green	Light Green	Light Green	Light Green	Light Green	Light Green
LEDstrip 24V Line IP67	10	10	512	Light Green	Light Green	Light Green	Light Green	Light Green	Light Green	Light Green	Light Green	Light Green	Light Green	Light Green	Light Green	Light Green	Light Green	Light Green	Light Green	Light Green	Light Green
LEDstrip 230V MidLum IP65	7	12	120	Light Green	Light Green	Light Green	Light Green	Light Green	Light Green	Light Green	Light Green	Light Green	Light Green	Light Green	Light Green	Light Green	Light Green	Light Green	Light Green	Light Green	Light Green
LEDstrip 230V HighLum IP65	15	12	120	Light Green	Light Green	Light Green	Light Green	Light Green	Light Green	Light Green	Light Green	Light Green	Light Green	Light Green	Light Green	Light Green	Light Green	Light Green	Light Green	Light Green	Light Green
LEDstrip 24V IP20 RGB	10,6	10	60	Light Green	Light Green	Light Green	Light Green	Light Green	Light Green	Light Green	Light Green	Light Green	Light Green	Light Green	Light Green	Light Green	Light Green	Light Green	Light Green	Light Green	Light Green
LEDstrip 24V IP20 RGBW	17,6	12	60	Light Green	Light Green	Light Green	Light Green	Light Green	Light Green	Light Green	Light Green	Light Green	Light Green	Light Green	Light Green	Light Green	Light Green	Light Green	Light Green	Light Green	Light Green
LEDstrip 24V IP20 TW	18,9	10	120	Light Green	Light Green	Light Green	Light Green	Light Green	Light Green	Light Green	Light Green	Light Green	Light Green	Light Green	Light Green	Light Green	Light Green	Light Green	Light Green	Light Green	Light Green
LEDstrip 24V IP67 RGB	10,6	12	60	Light Green	Light Green	Light Green	Light Green	Light Green	Light Green	Light Green	Light Green	Light Green	Light Green	Light Green	Light Green	Light Green	Light Green	Light Green	Light Green	Light Green	Light Green
LEDstrip 24V IP67 RGBW	13	14	60	Light Green	Light Green	Light Green	Light Green	Light Green	Light Green	Light Green	Light Green	Light Green	Light Green	Light Green	Light Green	Light Green	Light Green	Light Green	Light Green	Light Green	Light Green
LEDstrip 24V IP67 TW	18,9	12	120	Light Green	Light Green	Light Green	Light Green	Light Green	Light Green	Light Green	Light Green	Light Green	Light Green	Light Green	Light Green	Light Green	Light Green	Light Green	Light Green	Light Green	Light Green

- Suitable for profiles with all types of cover (Cover Opal is recommended for even lighting with visible installation)
- Suitable for profiles with all types of cover (Cover Opal High is recommended for even lighting with visible installation)
- Suitable for profile with all types of cover
- Suitable for profile with cover(except 7392971121413)
- Suitable for profile with high version cover
- Suitable for profile without cover
- Suitable for profile but there is no cover
- Not suitable for this profile
- Must be centred to fit
- X Not recommended (insufficient material in the profile to sufficiently cool the LEDstrip)

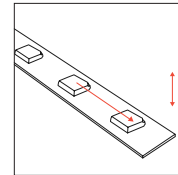

An opal cover can give even lighting if you think about the following relationship between LED strip and profile.

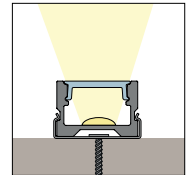

The distance between diodes must be less than the distance between diodes and cover.

It is possible to paint selected profiles, however, the profiles also function as heat sinks for LEDstrips. Because of the heat conduction, aluminium decays and shrinks, which can lead to the paint cracking over time. The profiles should therefore be powder coated or painted with a suitable paint.