



## LEDSTRIP 24V IP20 HIGHLUM 2700K 5M

LEDstrip 24V IP20 fås med tre lysfluks, Low, Mid og High, for å gjøre det lettere å finne det riktige lyset for det aktuelle stedet. Ønsker du en subtil og avslappende atmosfære? Velg Low. Trenger du kraftig belysning for å fremheve bestemte områder? Velg High. Perfekt når du vil tilpasse lyset for å skape karakter, uansett miljø. Passer utmerket i vårt sortiment av aluminiumsprofiler. Svært god fargegjengivelse, RA>90. Leveres som standard i ruller på fem meter med to meter tilkoblingskabel i hver ende, en hurtigkobling og selvklebende tape for enkel montering. Pakninger på fem meter inneholder produkter for å kunne lage tre ulike lengder etter eget ønske. På forespørsel leveres løpemeter med tilkoblingskabel etter ønske, standardleveranse av løpemeter skjer uten tilkoblingskabel. LEDstrip 24V kan også målbestilles i ønskede lengder. Driver bestilles separat etter ønsket dimmeteknologi og plassering.

### BESKRIVELSE

EL-nummer:	3227683
Item Name:	LEDstrip 24V IP20 Highlum 2700K 5m
Garanti:	5 år

### LYS TEKNISKE DATA

Max Armaturlumen (lm):	8175
Lyskilde:	LED
Lyskilde inngår:	Ja
Utskiftbarhet:	Non-replaceable LED
Lysfarge:	Varmhvit
Fargetemperatur (K):	2700
Fargegjengivelse (Ra):	>90
Fargetoleranse (SDCM):	3
Lysstyrke (cd):	475
Spredningsvinkel (°):	120
Lysspredning:	Symmetrisk
Lysfordeling:	Direkte
Antall lyskilder (stk):	1
Antall LED (stk):	800
Avstand LED (mm):	6
Levetid:	h Ta °C
Nominell levetid (t):	75000
Vedlikeholdt lumen 50 000h:	L82
Vedlikeholdt lumen 75 000h:	L79
LLMF @ 50 000h:	0.82

## TEKNISKE DATA

Spenning (Type):	DC
Spenningsintervall (V):	24...24V
Nominell spenning (V):	24
Forspenning (Vf):	3
Effekt armatur (W):	64
Systemeffekt (W):	70,4
Effektivitet armatur (lm/W):	128
Effektivitet system lm/W:	117
Energieffektivitetsklasse (EU) 2019/2015:	E

## DRIFT OG TILKOBLING

Dimmbar:	Ja
Driver inkludert:	Nei
Drivermodell:	Konstantspenning
Tilkobling (Type):	Kabelsett
Lenge tilførselsledning (cm):	200
Tilkobling (mm <sup>2</sup> ):	2x0,5
Min Ta (°C):	-20
Maks Ta (°C):	45
Maks Tc (°C):	70

## FARGE OG MATERIALE

Materiell:	Kobber
Farge:	Hvit

## DIMENSJON OG INSTALLASJON

Driftsmiljø:	Innendørs / tørre rom
IP-klasse:	20
Beskyttelsesklasse:	III
Montering:	Utenpåliggende
Innfesting:	Selvklebende tape
Godkjenningsmerknad:	CE
Krever kjøling:	Nei
Lengde (mm):	5000
Bredde (mm):	8
Høyde (mm):	2
Vekt (kg):	0,192

## LYS-I-METER

Min bøyingsradius (mm):	60
Min lengde (m):	0,05
Maks lengde (m):	5
Tilkoblingsintervall (mm):	50



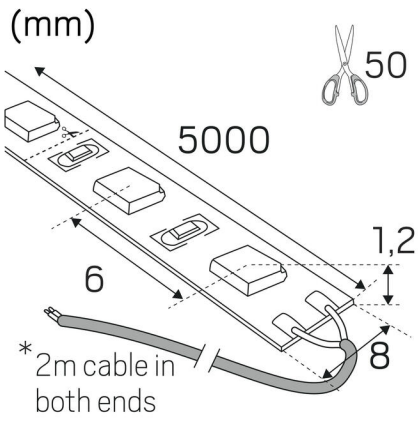

### Hide-a-lite

LEDstrip 24V Highlum 2700K



**6**  
kWh/1000h



2019/2015