



## OPTIC TRACK S 15° BLACK 2700K

Dimmable tracklights with replaceable LED and driver – built for the future. With reflector technology, high luminous efficacy is ensured with distinct and clear light distribution – perfect as accent lighting when you want to direct the light onto what you want to highlight, but also as general lighting in both private and public environments. Low-build universal adapter for 3-phase track. For improved glare reduction, the Honeycomb accessory can be added to the luminaire. You can easily replace the reflector with a lens accessory to adjust the light distribution as needed (XS, XXS). Suitable for most 3-phase track systems, e.g. Global Trac, (Erco for phase dimming).

### DESCRIPTION

<b>GTIN:</b>	7392971140513
<b>Item Name:</b>	Optic Track S 15° Black 2700K
<b>Warranty:</b>	5 years

### LIGHT TECHNICAL DATA

<b>Max. Luminaire Lumen (lm):</b>	950
<b>Light Source:</b>	LED
<b>Replaceability:</b>	Replaceable LED by professional, Replaceable Control gear by professional
<b>LED Colour:</b>	Warm White
<b>Colour Temperature (K):</b>	2700
<b>Colour Rendering Index (Ra):</b>	>90
<b>Colour Consistency (SDCM):</b>	3
<b>Luminous Intensity (cd):</b>	10450
<b>Beam Angle (°):</b>	15
<b>Light sharing:</b>	Symmetric
<b>Light Outlet:</b>	Direct
<b>Number of Lamps (pcs):</b>	1
<b>Number of LED (pcs):</b>	1
<b>Life Time:</b>	h Ta °C
<b>Nominal Life Time (h):</b>	100000
<b>Lumen maintenance 50 000h:</b>	L91
<b>Lumen maintenance 75 000h:</b>	L87
<b>Lumen maintenance 100 000h:</b>	L83
<b>LLMF @ 50 000h:</b>	0.91
<b>LLMF @ 100 000h:</b>	0.83
<b>Life Time Driver:</b>	50 000h/10%
<b>Flicker (PstLM):</b>	0,03
<b>Stroboscopic effect (SVM):</b>	0,04

## TECHNICAL DATA

Adjustable:	Yes
Tilttable (°):	90
Rotatable (°):	355
Voltage (type):	AC
Voltage Interval (V):	220...240V
Voltage Nominal (V):	230
Line Frequency (Hz):	50, 60
Power LED (W):	10
Max. Power Luminaire (W):	12
Max. System Power (W):	12
Max. Efficiency Luminaire (lm/W):	79,2
Max. Efficiency System (lm/W):	79,2
Containing light source energy efficiency class (EU) 2019/2015: F	
Eprel registration number:	869224

## OPERATION AND CONNECTION

Dimmable:	Yes
Type of Dimming:	Trailing Edge
Driver Included:	Yes - replaceable
Driver Model:	Constant Current
Driver Type:	Built-in
Connection (type):	3-phase universal adapter
Power Factor $\lambda$ :	0,92
Efficiency (%):	82
Power loss (W):	2,2
Leakage current (mA) (at 230 V, 50 Hz, full load):	0,25
THD (%):	20
Constant Current (mA):	300
Min. Ta (°C):	-20
Max. Ta (°C):	35
Max. Tc (°C):	78
Dimming secondary side:	AM
Suitable for random switching:	Yes
Inrush current (max/time):	10A 14 $\mu$ s
Mains surge protection DM (kV):	2
Fuse B10 (pcs):	30
Fuse B16 (pcs):	48
Fuse C10 (pcs):	50
Fuse C16 (pcs):	80

## COLOR AND MATERIAL

Material:	Aluminium
Color:	Black
Environmental Assessment:	Byggvarubedömningen
SCiP:	55eb7e0c-2d7f-4eb8-a2f5-6cc230414122

## MEASUREMENT AND INSTALLATION

Operating Environment:	Indoor / dry locations
IP Degree of Protection:	20
Protection Class:	II
Installation:	Light-track mounting
Mounting Installation:	3-phase Universal Adapter
Approval Marks:	CE, a Hide-a-lite Choice
Filament Test IEC 695-2-1(°C):	650
Length (mm):	195
Height (mm):	153
Diameter (mm):	83
Weight (kg):	0,7

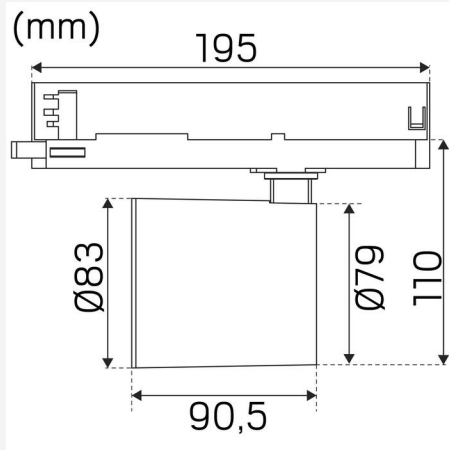

15°		2700K	
m	Ø (m)	Lux Emed/Emax	
1m	0,2	7200/10450	
3m	0,6	800/1160	
5m	0,9	290/420	
8m	1,9	110/180	
10m	2,3	70/110	

10450cd



hideolite  
choice

We focus on sustainability using recycled material for creating innovative luminaires, as well as replaceable LEDs and drivers.

Luminaires built for the future!