



OPTIC TRACK XS 1-PHASE 36° WHITE

Minimalist, dimmable tracklights with replaceable LED and driver – built for the future. Using the DIP-Switch colour temp function, colour temperature is easily adjusted with the touch of a button on the back of the luminaire (not Tune). With reflector technology, high luminous efficacy is ensured with distinct and clear light distribution – perfect as accent lighting when you want to direct the light onto what you want to highlight, but also as general lighting in both private and public environments. Low-build adapter for 1-phase track. For improved glare reduction, the Honeycomb accessory can be added to the luminaire. You can easily replace the reflector with a lens accessory to adjust the light distribution as needed. The kit contains four luminaires, two 1m 1-phase tracks, two connections, two end caps and one straight connector.

DESCRIPTION

GTIN:	7392971151342
Item Name:	Optic Track XS 1-phase 36° White
Warranty:	5 years

LIGHT TECHNICAL DATA

Max. Luminaire Lumen (lm):	770
Light Source:	LED
Replaceability:	Replaceable LED by professional, Replaceable Control gear by professional
LED Colour:	Warm White
Colour Temperature (K):	2700, 3000
Colour Rendering Index (Ra):	>90
Colour Consistency (SDCM):	3
Luminous Intensity (cd):	2000
Beam Angle (°):	36
Light sharing:	Symmetric
Light Outlet:	Direct
Number of Lamps (pcs):	1
Number of LED (pcs):	1
Life Time:	h Ta °C
Nominal Life Time (h):	100000
Lumen maintenance 50 000h:	L90
Lumen maintenance 75 000h:	L84
Lumen maintenance 100 000h:	L81
LLMF @ 50 000h:	0.9
LLMF @ 100 000h:	0.81
Life Time Driver:	100 000h/8%
Flicker (PstLM):	0,01
Stroboscopic effect (SVM):	0,01

TECHNICAL DATA

Adjustable:	Yes
Tilttable (°):	90
Rotatable (°):	350
Voltage (type):	AC
Voltage Interval (V):	220...240V
Voltage Nominal (V):	230
Line Frequency (Hz):	50
Power LED (W):	8,1
Max. Power Luminaire (W):	9,7
Max. System Power (W):	9,7
Max. Efficiency Luminaire (lm/W):	79,4
Max. Efficiency System (lm/W):	79,4
Containing light source energy efficiency class (EU) 2019/2015:	F
Eprel registration number:	2257933

OPERATION AND CONNECTION

Dimmable:	Yes
Type of Dimming:	Trailing Edge
Driver Included:	Yes - replaceable
Driver Model:	Constant Current
Driver Type:	Built-in
Driver Manufacturer:	Hide-a-lite
Connection (type):	1-phase adapter
Power Factor λ:	0,9
Efficiency (%):	83
Power loss (W):	1,6
Leakage current (mA) (at 230 V, 50 Hz, full load):	0,05
THD (%):	16
Constant Current (mA):	220
Min. Ta (°C):	-20
Max. Ta (°C):	40
Max. Tc (°C):	85
Dimming secondary side:	AM
Protection Against:	Short Circuit, Overheating 120°C, Overload
Inrush current (max/time):	3A 42 μ s
Mains surge protection DM (kV):	1
Mains surge protection CM (kV):	2
Fuse B10 (pcs):	46
Fuse B16 (pcs):	75
Fuse C10 (pcs):	75
Fuse C16 (pcs):	125

COLOR AND MATERIAL

Material:	Aluminium
Color:	White
Environmental Assessment:	Byggvarubedömningen

MEASUREMENT AND INSTALLATION

Operating Environment:	Indoor / dry locations
IP Degree of Protection:	20
Protection Class:	I
Installation:	Light-track mounting
Mounting Installation:	1-phase Adapter
Approval Marks:	CE, a Hide-a-lite Choice
Filament Test IEC 695-2-1(°C):	650
Length (mm):	130
Height (mm):	107
Diameter (mm):	60
Weight (kg):	0,39

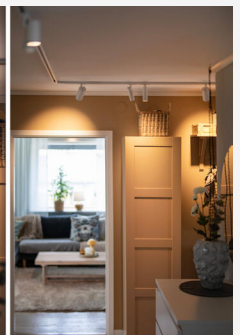
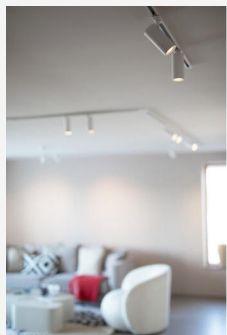

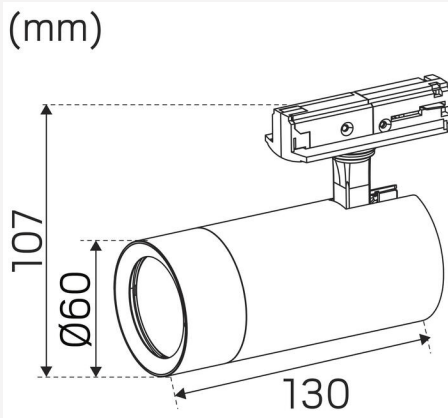
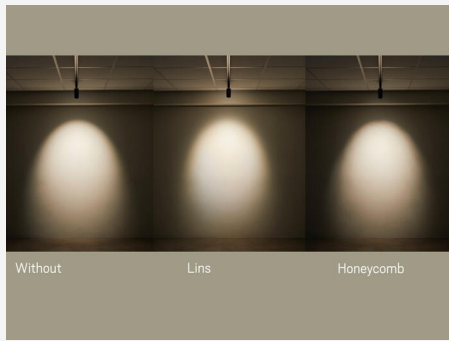
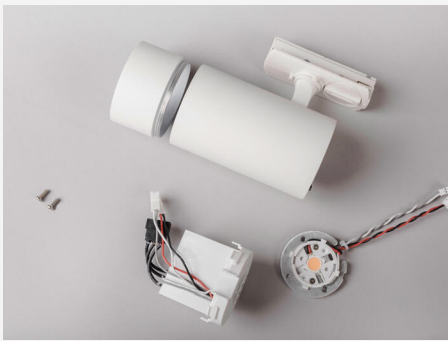
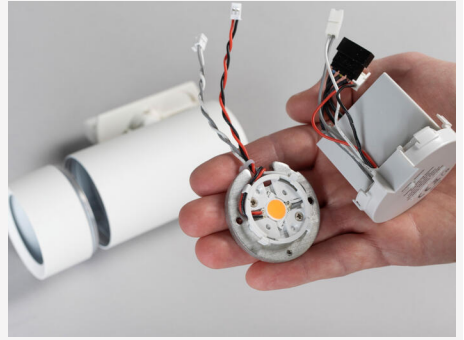
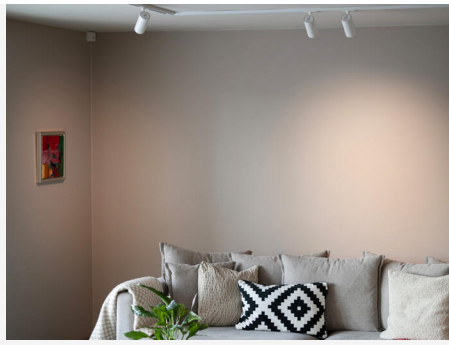

36°			2700K		
m	∅ (m)	Lux Emed/Emax			
1m	0,67	1457/1964			
2m	1,35	364/491			
3m	2,03	161/218			
4m	2,71	91/123			
			1950cd		

36°			3000K		
m	∅ (m)	Lux Emed/Emax			
1m	0,67	1480/2013			
2m	1,35	370/503			
3m	2,03	164/223			
4m	2,71	93/126			
			2000cd		



We focus on sustainability using recycled material for creating innovative luminaires,
as well as replaceable LEDs and drivers.

Luminaires built for the future!