



VISION TRACK L 3-PHASE 44° BLACK

Discover Vision Track – where innovation meets installation. A tracklight that lets you choose your colour temperature from 2700K to 6500K, with or without RGB, and, with the aid of AI technology, can identify and intensify the surface colours of an illuminated object. Ideal for raising the colours of an object to a whole new level. Outstanding in dynamic environments such as car showrooms, museums, supermarkets and clothing stores – everywhere intensified colours make a difference. Maximise the colours of your subject with Vision Track Pro, which adjusts the settings automatically, or manually using our simple app for customised lighting. The luminaire has lens technology with a high luminous efficacy and is available in black or white. Vision Track can act as a secondary unit to Vision Track Pro. All models have Bluetooth Mesh for easy control of several luminaires. Low-build universal adapter for 3-phase track, supplied complete with integrated driver.

DESCRIPTION

GTIN:	7392971152103
Item Name:	Vision Track L 3-phase 44° Black
Warranty:	5 years

LIGHT TECHNICAL DATA

Max. Luminaire Lumen (lm):	1800
Light Source:	LED
Replaceability:	Non-replaceable LED and control gear
Colour Temperature (K):	3000
Range Colour Temperature (K):	2700-6500
Colour Rendering Index (Ra):	>90
Colour Consistency (SDCM):	3
Luminous Intensity (cd):	3500
Beam Angle (°):	44
Light sharing:	Symmetric
Light Outlet:	Direct
Number of Lamps (pcs):	1
Number of LED (pcs):	1
Life Time:	h Ta °C
Nominal Life Time (h):	100000
Lumen maintenance 50 000h:	L90
Lumen maintenance 75 000h:	L80
Lumen maintenance 100 000h:	L70
LLMF @ 50 000h:	0.9
LLMF @ 100 000h:	0.7
Life Time Driver:	50 000h/5%
Flicker (PstLM):	0,8
Stroboscopic effect (SVM):	0,1

TECHNICAL DATA

Adjustable:	Yes
Tilttable (°):	90
Rotatable (°):	360
Voltage (type):	AC
Voltage Interval (V):	220...240V
Voltage Nominal (V):	230
Line Frequency (Hz):	50
Power LED (W):	26
Max. Power Luminaire (W):	30
Max. System Power (W):	30
Max. Efficiency Luminaire (lm/W):	60
Max. Efficiency System (lm/W):	60
Containing light source energy efficiency class (EU) 2019/2015: F	
Eprel registration number:	2053971

OPERATION AND CONNECTION

Dimmable:	Yes
Type of Dimming:	Bluetooth
Driver Included:	Yes
Driver Model:	Constant Current
Driver Type:	Built-in
Driver Manufacturer:	Hide-a-lite
Connection (type):	3-phase universal adapter
Power Factor λ:	0,9
Efficiency (%):	86
Power loss (W):	4
Leakage current (mA) (at 230 V, 50 Hz, full load):	0,05
THD (%):	15
Standby Power:	1,5
Constant Current (mA):	720
Min. Ta (°C):	-10
Max. Ta (°C):	30
Max. Tc (°C):	85
Dimming secondary side:	AM
Memory Function Power Failure:	Yes
Protection Against:	Short Circuit, Overheating 120°C, Overload
Inrush current (max/time):	35A 118 μ s
Mains surge protection DM (kV):	1
Mains surge protection CM (kV):	2
Fuse B10 (pcs):	24
Fuse B16 (pcs):	38
Fuse C10 (pcs):	40
Fuse C16 (pcs):	64

COLOR AND MATERIAL

Material:	Aluminium
Color:	Black
Environmental Assessment:	Byggvarubedömningen
Available in special color:	No
SCIP:	ba4e5a05-fd6e-4342-9344-f15f3223c77c

MEASUREMENT AND INSTALLATION

Operating Environment:	Indoor / dry locations
IP Degree of Protection:	20
Protection Class:	II
Installation:	Light-track mounting
Mounting Installation:	3-phase Universal Adapter
Approval Marks:	CE
Filament Test IEC 695-2-1(°C):	650
Length (mm):	210
Height (mm):	170
Diameter (mm):	80
Weight (kg):	0,822

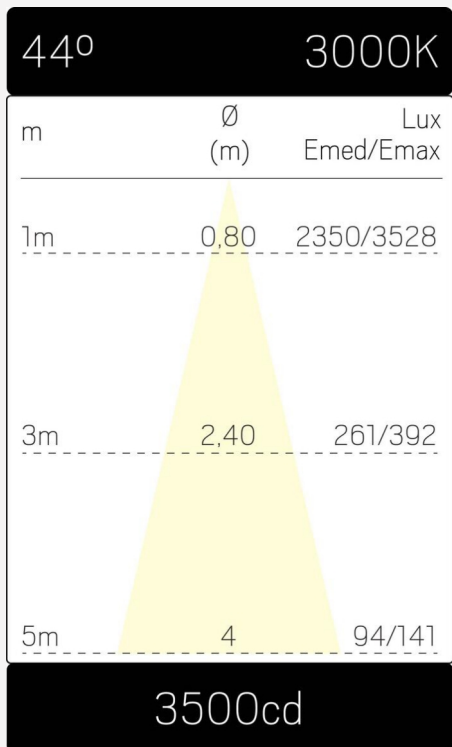
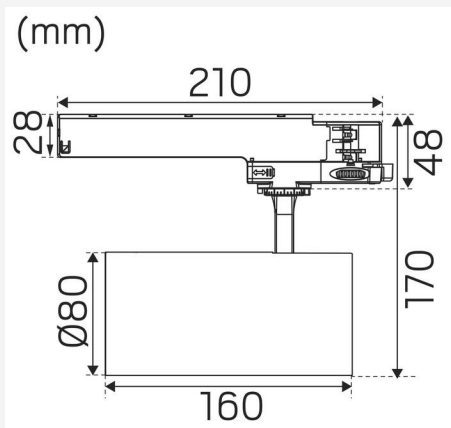
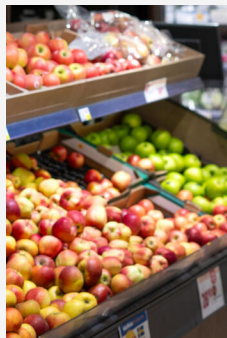
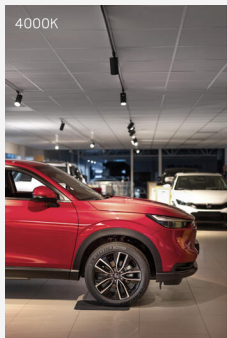
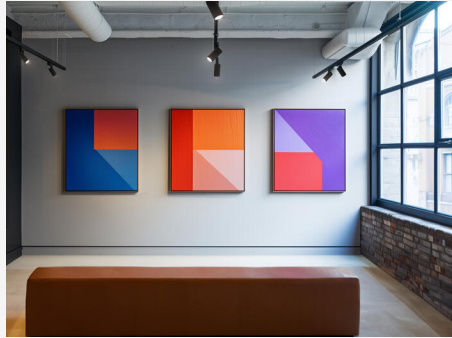
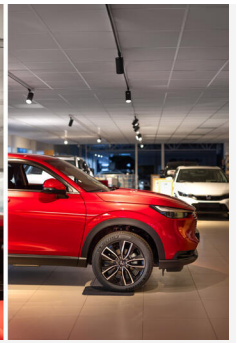
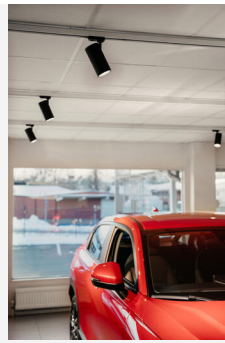

VISION TRACK L / PRO

Kelvin	Watt	Lumen	
		20°	44°
2700	30	1900	1550
3000	30	2200	1800
4000	26	2000	1550
6500	21	1300	1060
Red	9	180	140
Green	9	550	430
Blue	9	360	290